

jura[®]

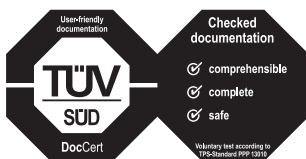

JURA F9 Instructions for Use



The Instructions for Use has been awarded the seal of approval by the independent German Technical Inspection Agency, TÜV SÜD, due to its easy-to-understand style, its thoroughness and coverage of safety aspects.



Your JURA F9

Control elements	4
Important information	6
Proper use	6
For your safety.....	6
1 Preparing and using for the first time	10
JURA on the Internet.....	10
Setting up the machine	10
Filling the bean container.....	10
First-time use	10
Determining the water hardness	13
Connecting milk.....	14
Filling the water tank.....	14
2 Preparation	15
Ways of preparing a beverage	15
Ristretto, espresso and coffee.....	16
Two ristretti, two espressi and two coffees	16
Latte macchiato, cappuccino and other speciality coffees with milk.....	17
Ground coffee	18
Permanently setting the amount of water for the cup size	19
Adjusting the grinder	20
Hot water	20
3 Daily operation	21
Switching on the machine.....	21
Daily maintenance.....	21
Regular maintenance	22
Switching off the machine.....	22
4 Permanent settings in programming mode	23
Product settings	24
Adjusting the product settings.....	24
Replacing products on the start screen	25
Renaming a product.....	26
Automatic switch-off	27
Energy-saving mode	28
Maintenance settings.....	28
Setting the water hardness	29
Display settings	30
Unit for amount of water.....	30
Restore factory settings	31
Language	31
Querying information	32



5	Maintenance	33
	Rinsing the machine.....	33
	Rinsing the milk system.....	34
	Cleaning the milk system	34
	Dismantling and rinsing the dual spout.....	35
	Inserting and activating the filter.....	36
	Changing the filter	37
	Cleaning the machine	39
	Descaling the machine	40
	Descaling the water tank.....	42
	Cleaning the bean container.....	42
6	Display messages	43
7	Troubleshooting	44
8	Transport and environmentally friendly disposal	45
	Transport / Emptying the system.....	45
	Disposal.....	45
9	Technical data	46
10	Index	47
11	JURA contact details / Legal information	52

Symbol description

Warnings

 WARNING	Always take note of any information marked with the words CAUTION or WARNING and a warning sign. The signal word WARNING draws your attention to potential serious injury, and the signal word CAUTION to potential minor injury.
 CAUTION	CAUTION draws your attention to potential damage to the machine.

Symbols used

	Prompt to take action. This symbol means that you are being prompted to perform some action.
	Information and tips to make it even easier to use your JURA F9.
	Display

Control elements

Control elements





- 1 Bean container with aroma preservation cover
- 2 Water tank cover
- 3 Water tank
- 4 Power switch and mains cable (back of the machine)
- 5 Coffee grounds container
- 6 Drip tray
- 7 Cup grille

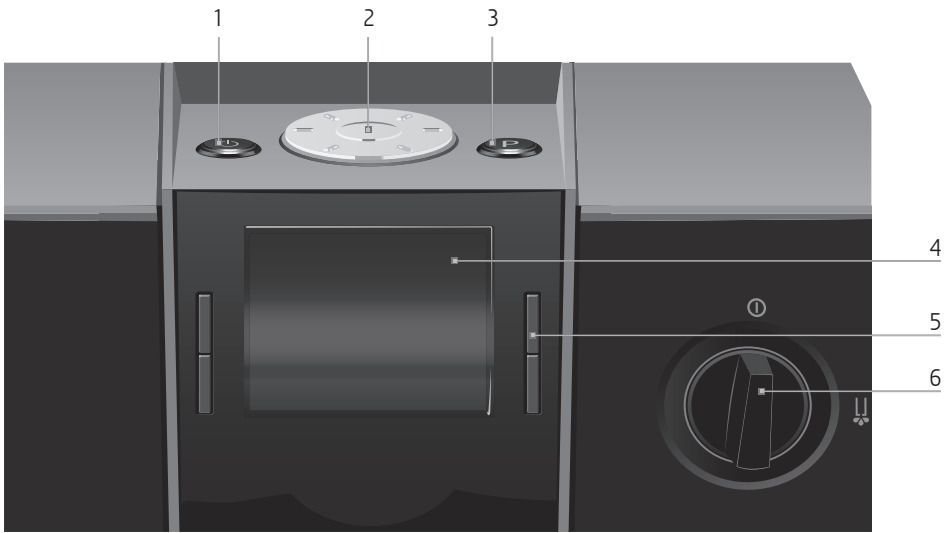

- 8 Filler funnel cover
- 9 Filler funnel for ground coffee
- 10 Storage compartment cover
- 11 Grinder adjustment switch
- 12 Measuring spoon for ground coffee
- 13 Hot-water spout
- 14 Height-adjustable dual spout



Top of the machine

- 1  On/Off button
- 2  Rotary Switch
- 3  P button (programming)

Front

- 4  Display
- 5  Multi-function buttons (button function depends on what is shown in the display)
- 6  Switch for hot water preparation

Important information

Proper use

The machine is designed and intended for private domestic use. It should only be used for coffee preparation and to heat milk and water. Use for any other purpose will be deemed improper. JURA Elektroapparate AG cannot accept any responsibility for the consequences of improper use.

Before using the machine read these instructions for use thoroughly and completely and comply with the instructions they contain. A warranty service is not applicable for damage or defects caused by non-compliance with the instructions for use. Keep these instructions for use close to the machine and pass them on to the next user.

For your safety



Please carefully read and observe the important safety information set out below.

To avoid danger of potentially fatal electric shock:

- Never use a machine which is damaged or has a defective mains cable.
- In the event of signs of damage, for example if there is a smell of burning, unplug the machine immediately from the mains supply and contact JURA service.
- If the mains cable of this machine is damaged, it must be repaired either directly by JURA or by an authorised JURA service centre.
- Make sure that the JURA F9 and the mains cable are not located close to hot surfaces.
- Be careful to ensure that the mains cable is not trapped and does not rub against sharp edges.

- Never open and repair the machine yourself. Do not modify the machine in any way that is not described in these instructions for use. The machine contains live parts. If opened, there is a danger of potentially fatal injury. Repairs may only be carried out by authorised JURA service centres, using original spare parts and accessories.
- To completely and safely disconnect the machine from the power supply, first switch off the JURA F9 using the On/Off button and then at the power switch. Only then should you remove the mains plug from the power socket.

There is a risk of scalds or burns on the spouts.

- Place the machine out of the reach of children.
- Do not touch any hot parts. Use the handles provided.

A defective machine is not safe and could cause injury or fire. To avoid damage and any associated risk of injury or fire:

- Never allow the mains cable to loosely hang down. The mains cable could pose a tripping hazard or become damaged.
- Protect the JURA F9 from environmental influences such as rain, frost and direct sunlight.
- Do not immerse the JURA F9, mains cable or connections in water.
- Do not put the JURA F9 or any individual parts in the dishwasher.
- Switch your JURA F9 off at the power switch before any cleaning operation. Always wipe the JURA F9 with a damp cloth rather than a wet one, and protect it from prolonged exposure to water splash.

Important information

- Only connect the machine to the mains voltage in accordance with the information on the rating plate. The rating plate is located on the underside of your JURA F9. Further technical data is provided in these instructions for use (see Chapter 9 'Technical data').
- Connect the JURA F9 directly to a domestic power socket. Using multi-socket adapters or extension cords may cause overheating.
- Please only use original JURA maintenance products. Use of products that are not explicitly recommended by JURA could damage the JURA F9.
- Do not use any coffee beans treated with additives or caramelised coffee beans.
- Only fill the water tank with fresh, cold water.
- Switch the machine off at the power switch if you are going to be absent for a longer period of time.
- Children may not clean or service the machine unless supervised by a responsible person.
- Do not allow children to play with the machine.
- Keep children under the age of 8 away from the machine, or supervise them constantly.
- Children aged 8 and over may only operate the machine without supervision if they have been instructed in how to use it safely. Children must be able to recognise and understand the potential dangers arising from incorrect use.

People, including children, who

- do not have the physical, sensory or mental capabilities to use the machine safely or
- are inexperienced or lack knowledge in how to use the machine safely

must be supervised by a responsible person when using it, or must be instructed in how to use it correctly.

Safety when handling the CLARIS Blue filter cartridge:

- Filter cartridges should be kept out of the reach of children.
- Store filter cartridges in a dry place in the sealed packaging.
- Protect cartridges from heat and direct sunlight.
- Do not use damaged filter cartridges.
- Do not open filter cartridges.

1 Preparing and using for the first time

JURA on the Internet

Visit us on the Internet. You can download **short operating instructions** for your machine from the JURA website (www.jura.com). You will also find interesting and up-to-date information on your JURA F9 and on every aspect of coffee.

Setting up the machine



When setting up your JURA F9, please note the following:

- Place the JURA F9 on a horizontal surface that is not sensitive to water.
- Choose a spot for your JURA F9 which protects the machine against overheating. Ensure that the ventilation slots are not covered.

Filling the bean container

CAUTION

Coffee beans which have been treated with additives (e.g. sugar), ground coffee or freeze-dried coffee will damage the grinder.

- ▶ Only use roasted, untreated coffee beans to fill the bean container.
-
- ▶ Remove the aroma preservation cover.
 - ▶ Remove any dirt or foreign objects from inside the bean container.
 - ▶ Fill the bean container with coffee beans and close the aroma preservation cover.

First-time use

When using the machine for the first time, you can choose whether you want to operate JURA F9 **with** or **without** the CLARIS Blue filter cartridge. If the water hardness is 10 °dH or more, we recommend using the filter cartridge. If you do not know the hardness of your water, you can find this out first (see Chapter 1 'Preparing and using for the first time – Determining the water hardness').

⚠ WARNING

If the machine is operated with a defective mains cable, there is a danger of potentially fatal electric shock.

- ▶ Never use a machine which is damaged or has a defective mains cable.

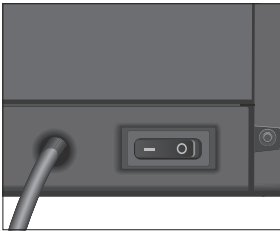

Precondition: The bean container has been filled.

- ▶ Insert the mains plug into a power socket.
- ▶ Switch on the JURA F9 using the power switch on the back of the machine.
- ▶ Press the On/Off button to switch the JURA F9 on. The display shows the languages you can choose from.

- i** To display more languages, press the ‘>’ button (bottom right).
- ▶ Press the button that corresponds to the language you want, e.g. ‘English’.
- ‘Saved’ appears briefly on the display to confirm the setting.
- ‘Use filter’

- i** Now decide whether you want to operate your JURA F9 **with** or **without** a CLARIS Blue filter cartridge.

First-time use with filter cartridge activation

CAUTION

Milk, sparkling mineral water or other liquids can damage the water tank or the machine.

- ▶ Only fill the water tank with fresh, cold water.



- ▶ Press the ‘Active’ button.
- ▶ Press the ‘Save’ button.
- ‘Saved’ appears briefly on the display.
- ‘Insert filter’
- ▶ Remove the water tank and rinse it with cold water.
- ▶ Open the filter holder and insert the filter cartridge into the water tank, exerting slight pressure.
- ▶ Close the filter holder. It will click into place audibly.

- i** After two months, the filter will cease to work. Set the date on the date plate on the filter holder in the water tank.



1 Preparing and using for the first time



- ▶ Fill the water tank with fresh, cold water and reinsert the tank.
 - ▶ Press the **'Next'** button.
'Switch open'
 - ▶ Place a receptacle under the hot-water spout and dual spout.
 - ▶ Turn the switch to the  position.
'Filter is being rinsed', water flows out of the hot-water spout.
 - i** You can interrupt rinsing of the filter at any time. To do this, turn the switch clockwise. Turn the switch anticlockwise to continue rinsing the filter.
 - i** The water may be slightly discoloured. This is not harmful to health and does not affect the taste.
- Rinsing of the filter stops automatically after approximately 300 ml. **'Switch close'** appears on the display.
- ▶ Turn the switch to the  position.
'System is filling', the system fills up with water.
'Machine is heating', the machine heats up.
'Machine is rinsing', the system is rinsed. The rinse stops automatically. **'Please select product'** appears on the display.
Your JURA F9 is ready for use.

- i** The display shows the products you can prepare.

First-time use without filter cartridge activation

CAUTION

Milk, sparkling mineral water or other liquids can damage the water tank or the machine.

- ▶ Only fill the water tank with fresh, cold water.

- ▶ Press the **'Inactive'** button.
- ▶ Press the **'Save'** button.
'Saved' appears briefly on the display.
'Water hardness'

- i** If you do not know the hardness of your water, you must find this out first (see Chapter 1 'Preparing and using for the first time – Determining the water hardness').

1 Preparing and using for the first time

- Turn the Rotary Switch to change the water hardness setting, e.g. to '25 °dH'.
- Press the 'Save' button.
'Saved' appears briefly on the display.
'Fill water tank.'
- Remove the water tank and rinse it with cold water.
- Fill the water tank with fresh, cold water and reinsert the tank.
'Switch open'

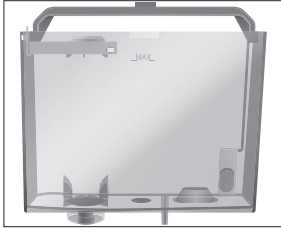

- Place a receptacle under the hot-water spout and dual spout.
- Turn the switch to the ↓ position.
'System is filling', water flows out of the hot-water spout. The operation stops automatically. 'Switch close' appears on the display.
- Turn the switch to the ⊕ position.
'System is filling', the system fills up with water.
'Machine is heating', the machine heats up.
'Machine is rinsing', the system is rinsed. The rinse stops automatically. 'Please select product' appears on the display. Your JURA F9 is ready for use.

i The display shows the products you can prepare.

Determining the water hardness

You can find out what the water hardness is by using the Aquadur® test strip supplied as standard.

- Hold the test strip briefly (for 1 second) under flowing water. Shake off the water.
- Wait for about 1 minute.
- You will then be able to read the degree of water hardness from the discolouration of the Aquadur® test strip and the description on the packaging.

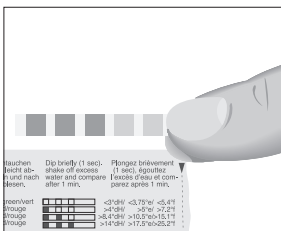

1 Preparing and using for the first time

Connecting milk

Your JURA F9 creates fine, creamy, feather-light milk foam with a perfect consistency. The most important requirement for frothing milk is a milk temperature of 4–8 °C. We would therefore recommend using a milk cooler or a vacuum milk container.

- ▶ Remove the protective cover from the dual spout.

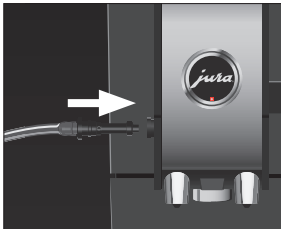
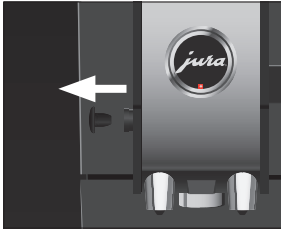

- ▶ Connect the milk pipe to the dual spout.
- ▶ Connect the other end of the milk pipe to a milk container or immerse it in a milk carton.

Filling the water tank

Daily maintenance of the machine and hygiene when handling milk, coffee and water are key to a perfect coffee result in the cup every time. You should therefore change the water **daily**.

CAUTION



Milk, sparkling mineral water or other liquids can damage the water tank or the machine.

- ▶ Only fill the water tank with fresh, cold water.

- ▶ Open the water tank cover.
- ▶ Remove the water tank and rinse it with cold water.
- ▶ Fill the water tank with fresh, cold water and reinsert the tank.
- ▶ Close the water tank cover.



2 Preparation

- i** You can stop the machine at any time while a speciality coffee or hot water is being prepared. Just press any button (for a speciality coffee) or return the switch to its original position (for hot water preparation).
- i** During the grinding operation you can select the coffee strength of **single products** by turning the Rotary Switch .
- i** During preparation, you can change the preset **amount of water or milk foam** by turning the Rotary Switch .
- i** You can follow the current status of preparation on the display.

Coffee tastes best served hot. A cold porcelain cup cools the beverage – and impairs the taste. We therefore recommend prewarming the cups. The full coffee aroma can develop only in prewarmed cups. You can purchase a JURA cup warmer from your specialised dealer.

You can make **permanent settings** for all products in programming mode (see Chapter 4 ‘Permanent settings in programming mode – Adjusting the product settings’).

Ways of preparing a beverage

The JURA F9 offers various ways of preparing a speciality coffee, milk foam or hot water:

- **Preparation using the start screen:** Simply press the corresponding preparation button for the product shown on the display (start screen) that you want.
The following products are displayed as standard on the start screen:
 - ‘Espresso’
 - ‘Coffee’
 - ‘Flat white’
 - ‘Latte macchiato’
- **Using the product selector view (Rotary Selection):** Only some of the products you can prepare are shown on the start screen. As soon as you turn the Rotary Switch, more products are displayed in a **product selector view**.
Turn the Rotary Switch to bring the product you want into focus. Start preparation by pressing the Rotary Switch or the ‘Prepare’ button.

2 Preparation

The following **additional** products are shown in the product selector view:

- 'Ristretto'
- '2 ristretti'
- '2 espressi'
- '2 coffees'
- 'Special'
- 'Cappuccino'
- 'Macchiato'
- 'Caffè latte'
- 'Portion milk foam'

- i** The product selector view disappears automatically after 10 seconds if no preparation is started.
- i** You have the option of replacing the four products on the start screen with your personal favourites (see Chapter 4 'Permanent settings in programming mode – Replacing products on the start screen'). Please note that the descriptions provided in the following sections always refer to the default settings.

Ristretto, espresso and coffee



Example: Proceed as follows to prepare one coffee.

Precondition: 'Please select product' is displayed.

- ▶ Place a cup under the dual spout.
- ▶ Press the 'Coffee' button.
Preparation starts. 'Coffee' and the coffee strength are displayed. The preset amount of water for coffee flows into the cup.
Preparation stops automatically. 'Please select product' appears on the display.

Two ristretti, two espressi and two coffees

There are several ways of preparing **two** speciality coffees.

- Using the **product selector view**:
 - Bring one of the double products '2 ristretti', '2 espressi' or '2 coffees' into focus and press the Rotary Switch or the button 'Prepare'.
- When preparing a single product:
 - Press the single product button twice **within 2 seconds** to start preparing the relevant double product.

Example: Proceed as follows to prepare **two coffees** (using product selector view).

Precondition: The start screen is displayed.

- ▶ Place two cups under the dual spout.
- ⊖ ▶ Turn the Rotary Switch to view the product selector.
- ⊖ ▶ Turn the Rotary Switch until the **'2 coffees'** product is in focus.
- ⊖ ▶ Press the Rotary Switch to start preparation.
Coffee preparation starts. The preset amount of water for coffee flows into the cups. Preparation stops automatically. Your JURA F9 is once more ready for use.



Latte macchiato, cappuccino and other speciality coffees with milk

Your JURA F9 prepares latte macchiato, cappuccino, flat white and other speciality coffees with milk at the touch of a button. There is no need to move the glass or cup.

Example: Proceed as follows to prepare one latte macchiato.

Precondition: **'Please select product'** is displayed. Milk is connected to the dual spout.

- ▶ Place a glass under the dual spout.
- ▶ Press the **'Latte macchiato'** button.
'Latte macchiato', the preset amount of milk foam flows into the glass.

i There is a short interval while the hot milk separates from the milk foam. This allows the typical layers of a latte macchiato to form.

Coffee preparation starts. The preset amount of water for espresso flows into the glass. Preparation stops automatically. **'Please select product'** appears on the display.

To ensure that the milk system in the dual spout always works properly, you must clean it **daily** (see Chapter 5 'Maintenance – Cleaning the milk system').



Ground coffee

You can choose to use a second coffee variety, for example decaffeinated coffee, with the filter funnel for ground coffee.

- i** Never add more than two level measuring spoons of ground coffee.
- i** Use ground coffee which is not ground too finely. Very fine coffee can block up the system so that the coffee only comes out in drips.
- i** If you did not fill the machine with a sufficient amount of ground coffee, 'Not enough ground coffee' is displayed and the JURA F9 stops the operation.
- i** The desired speciality coffee must be prepared within approximately one minute after filling with the ground coffee. Otherwise the JURA F9 stops the operation and is once more ready for use.

All speciality coffees with ground coffee are always prepared following the same model.

Example: Proceed as follows to prepare one espresso using ground coffee.

Precondition: 'Please select product' is displayed.

- ▶ Place an espresso cup under the coffee spout.
- ▶ Open the cover of the filler funnel for ground coffee.
'Please add ground coffee'
- ▶ Place one level measuring spoon of ground coffee into the filler funnel.
- ▶ Close the cover of the filler funnel.
'Please select product'
- ▶ Press the 'Espresso' button.
Preparation starts. 'Espresso', the preset amount of water for espresso flows into the cup.
Preparation stops automatically. 'Please select product' appears on the display.



Permanently setting the amount of water for the cup size



It is easy to permanently adjust the amount of water for all **single products** to the cup size. Adjust the amount once as shown in the following example. Every time you prepare a drink in the future, this amount will be dispensed.

Example: Proceed as follows to **permanently** set the amount of water for one coffee.

Precondition: 'Please select product' is displayed.

- ▶ Place a cup under the dual spout.
- ▶ Press and **hold** the 'Coffee' button until 'Enough coffee? Press button' appears.
- ▶ Release the 'Coffee' button.
Preparation starts and the coffee flows into the cup.
- ▶ Press any button as soon as there is sufficient coffee in the cup.
Preparation stops. 'Saved' appears briefly on the display. The set amount of water for one coffee is permanently stored. 'Please select product' appears on the display.

- i** You can alter this setting at any time by repeating the above procedure.
- i** The amount can be permanently adjusted to the cup size for the products shown in the product selector too. To do this, press and hold the Rotary Switch  until 'Enough coffee? Press button' appears.
- i** You can also permanently set the amount of water for all speciality coffees and hot water in programming mode (see Chapter 4 'Permanent settings in programming mode – Adjusting the product settings').

2 Preparation

Adjusting the grinder

You can adjust the grinder on a continuous scale to suit the degree of roast of your coffee.

CAUTION

If you adjust the consistency of grind when the grinder is not operating, the grinder adjustment switch could be damaged.

- ▶ Only adjust the consistency of grind when the grinder is running.

The consistency of grind is correct if the coffee flows regularly from the coffee spout. In addition a fine, thick crema forms.

Example: Proceed as follows to change the consistency of grind **during** the preparation of an espresso.

- ▶ Place a cup under the coffee spout.
- ▶ Open the storage compartment cover.
- ▶ Press the **'Espresso'** button to start preparation.
- ▶ Turn the grinder adjustment switch to the desired position **while** the grinder is running.
The preset amount of water flows into the cup. Preparation stops automatically.
- ▶ Close the storage compartment cover.

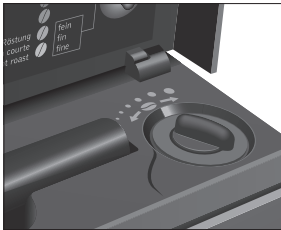

Hot water



⚠ CAUTION

There is a danger of scalding from hot water splashes.

- ▶ Avoid direct contact with the skin.



Precondition: **'Please select product'** is displayed.

- ▶ Place a cup under the hot-water spout.
- ▶ Turn the switch to the  position.
'Hot water', the preset amount of water flows into the cup.
Preparation stops automatically.
'Switch close'
- ▶ Turn the switch to the  position.
'Please select product' appears on the display.

3 Daily operation

Switching on the machine



Daily maintenance of the machine and hygiene when handling milk, coffee and water are key to a perfect coffee result in the cup every time. You should therefore change the water **daily**.

Precondition: Your JURA F9 is switched on at the power switch.

- ▶ Place a receptacle under the dual spout.
 - ☰ ▶ Press the On/Off button to switch the JURA F9 on.
 - ‘Welcome to JURA’
 - ‘Machine is heating’
 - ‘Machine is rinsing’, the system is rinsed. The rinse stops automatically. ‘Please select product’ appears on the display.
- Your JURA F9 is ready for use.

Daily maintenance



To ensure that you get many years of reliable service out of your JURA F9 and to guarantee the optimum coffee quality, the machine requires daily maintenance.

- ▶ Pull out the drip tray.
 - ▶ Empty the coffee grounds container and the drip tray. Rinse them both with warm water.
- i** Always empty the coffee grounds container when the machine is **switched on**. This is the only way of resetting the coffee grounds counter.
- ▶ Refit the coffee grounds container and the drip tray.
 - ▶ Rinse the water tank with clean water.
 - ▶ Remove the milk pipe and rinse it thoroughly under running water.
 - ▶ Dismantle and rinse the dual spout (see Chapter 5 ‘Maintenance – Dismantling and rinsing the dual spout’).
 - ▶ Wipe the surface of the machine with a clean, soft, damp cloth (e.g. microfibre cloth).

Regular maintenance

Carry out the following maintenance actions **regularly** or **as required**:

- In the interests of hygiene, we recommend changing the milk pipe on a regular basis (approximately every 3 months). Replacement pipes are available from specialised dealers (JURA original accessory set for frothers).
- Clean the inside of the water tank, e.g. with a brush. Further information about the water tank is provided in these instructions for use (see Chapter 5 'Maintenance – Descaling the water tank').
- Traces of milk and coffee may stick to the top and bottom of the cup grille. If this happens, clean the cup grille.

Switching off the machine



When the JURA F9 is switched off, the system is automatically rinsed if a speciality coffee has been prepared.

Precondition: 'Please select product' is displayed (or 'Rinse the milk system' if milk has been prepared).

- ▶ Place a receptacle under the dual spout.
- ▶ Press the On/Off button.
If milk has been prepared, the milk system is first rinsed ('Milk system is being rinsed').
'Machine is rinsing', the system rinses itself. The operation stops automatically. Your JURA F9 is switched off.

i When the JURA F9 is switched off with the On/Off button, the machine consumes less than 0.1 W of standby energy. The machine can be completely disconnected from the power supply using the power switch.

4 Permanent settings in programming mode

Press the P button to enter programming mode. You can navigate through the programme items and permanently save the required settings simply by turning the Rotary Switch and using the multi-function buttons. The following settings can be made:

Programme item	Sub-item	Explanation
'Maintenance status' ('1/7' and '2/7')	'Clean', 'Change the filter' (only if filter is activated), 'Descalc' (only if filter is not activated), 'Cappuccino cleaning', 'Rinse the coffee system', 'Rinse the milk system'	▶ Start the required maintenance programme here.
'Product settings' ('3/7')	'Expert mode', 'Factory setting'	▶ Select your settings for speciality coffees and hot water. ▶ Reset the settings for single products to their factory setting.
'Machine settings' ('4/7')	'Choose language', 'Switch off after', 'Save energy', 'Factory setting'	▶ Select your language. ▶ Set the time after which the JURA F9 should switch off automatically. ▶ Select an energy-saving mode. ▶ Reset the machine to its factory setting.
'Machine settings' ('5/7')	'Units', 'Display'	▶ Select the unit for the amount of water. ▶ Change the display settings.
'Maintenance settings' ('6/7')	'Use filter', 'Water hardness' (only if filter is not activated), 'Switch-on rinse'	▶ Indicate whether you are operating your JURA F9 with or without a CLARIS Blue filter cartridge. ▶ Adjust the water hardness. ▶ Change the settings for switch-on rinse.
'Information' ('7/7')	'Product counter', 'Maintenance counter', 'Version'	▶ Keep track of all products prepared and view the number of maintenance programmes performed.

Product settings

In the programme item ‘Product settings’ (‘3/7’) you can make the following settings:

- ‘Expert mode’
 - Set individual settings for all speciality coffees, milk and hot water (see Chapter 4 ‘Permanent settings in programming mode – Adjusting the product settings’).
 - Replace the products on the start screen with your favourites (see Chapter 4 ‘Permanent settings in programming mode – Replacing products on the start screen’).
 - Change the names of individual products (see Chapter 4 ‘Permanent settings in programming mode – Renaming a product’).
- ‘Factory setting’
 - Reset the set values for individual products to their factory setting.

Adjusting the product settings

In the programme item ‘Product settings’ (‘3/7’) / ‘Expert mode’ you can make individual settings for all speciality coffees and hot water. The following permanent settings can be made:

Product	Coffee strength	Amount	More settings
Ristretto, Espresso, Coffee, Special coffee	8 levels	Amount of coffee: 25 ml – 240 ml	Temperature (normal, high), Product name
2 ristretti, 2 espressi, 2 coffees	–	Amount of coffee: The amount set for the single product is doubled.	Temperature (as for single product), Product name
Cappuccino, Latte macchiato, Espresso macchiato, Caffè latte, Flat white	8 levels	Amount of coffee: 25 ml – 240 ml Milk foam: 0 sec. – 120 sec. Interval: 0 sec. – 120 sec. (not for caffè latte and flat white)	Temperature (normal, high), Product name
Portion of milk foam	–	Milk foam: 0 sec. – 120 sec.	Product name
Hot water	–	Water: 25 ml – 450 ml	Temperature (low, normal, high), Product name

Permanent settings in programming mode always follow the same model.

Example: Proceed as follows to change the coffee strength for one coffee.

Precondition: 'Please select product' is displayed.

- P ▶ Press the P button.
'Maintenance status' ('1/7')
- ⊙ ▶ Turn the Rotary Switch until 'Product settings' ('3/7') is displayed.
 - ▶ Press the 'Expert mode' button.
'Expert mode'
- i Next select the button of the product for which you would like to make settings. No product is prepared at this point.
 - ▶ Press the ' > ' button (bottom right) until 'Coffee' is displayed.
 - ▶ Press the 'Coffee' button.
'Coffee'
 - ▶ Press the 'Coffee strength' button.
'Coffee' / 'Coffee strength'
- ⊙ ▶ Turn the Rotary Switch to change the coffee strength setting.
 - ▶ Press the 'Save' button.
'Saved' appears briefly on the display.
'Coffee'
- P ▶ Press the P button to exit programming mode.
'Please select product'

Replacing products on the start screen

You have the option of replacing the four products on the start screen with your personal favourites.

Example: Proceed as follows to replace 'Latte macchiato' on the start screen with 'Macchiato'.

Precondition: 'Please select product' is displayed.

- P ▶ Press the P button.
'Maintenance status' ('1/7')
- ⊙ ▶ Turn the Rotary Switch until 'Product settings' ('3/7') is displayed.

4 Permanent settings in programming mode

- ▶ Press the 'Expert mode' button.
'Expert mode'
- ▶ Press the ' > ' button (bottom right) several times until 'Macchiato' is displayed.
- ▶ Press the 'Macchiato' button.
'Macchiato'
- ⊙ ▶ Press the ' > ' button (bottom right) until 'Add to favourites' is displayed.
- ▶ Press the 'Add to favourites' button.
'Select position'
- ▶ Press the 'Latte macchiato' button.
'Select position' / 'Do you want to replace the current product?'
- ▶ Press the 'Yes' button.
'Saved' appears briefly on the display.
'Macchiato'
- P ▶ Press the P button to exit programming mode.
'Please select product'



Renaming a product

In the programme item 'Product settings' / 'Expert mode' you can rename all of the products.

Example: Proceed as follows to change the product name of 'Espresso'.

Precondition: 'Please select product' is displayed.

- P ▶ Press the P button.
'Maintenance status' ('1/7')
- ⊙ ▶ Turn the Rotary Switch until 'Product settings' ('3/7') is displayed.
- ▶ Press the 'Expert mode' button.
'Expert mode'
- ▶ Press the ' > ' button (bottom right) until 'Espresso' is displayed.
- ▶ Press the 'Espresso' button.
'Espresso'
- ▶ Press the ' > ' button (bottom right) until 'Product name' is displayed.



- ▶ Press the 'Product name' button.
The available letters, numbers and special characters appear on the display.
- i** By pressing the 'abc/ABC' button, you can switch between lower and upper case letters.
-  ▶ Turn the Rotary Switch until the letter you want is highlighted.
-  ▶ Press the Rotary Switch to confirm the letter.
- ▶ Continue until the new product name you want is displayed.
- i** Please note that there is a maximum text length.
- ▶ Press the 'Save' button.
'Saved' appears briefly on the display.
The new product name is displayed.
- P** ▶ Press the P button to exit programming mode.
'Please select product'

Automatic switch-off

By instructing your JURA F9 to automatically switch itself off, you can cut down your energy consumption. If this function is activated, your JURA F9 switches off automatically after the preset time following the last action on the machine.

You can set the automatic switch-off to 15 minutes, 30 minutes or 1–9 hours.

Precondition: 'Please select product' is displayed.

- P** ▶ Press the P button.
'Maintenance status' ('1/7')
-  ▶ Turn the Rotary Switch until 'Machine settings' ('4/7') is displayed.
- ▶ Press the 'Switch off after' button.
'Switch off after'
-  ▶ Turn the Rotary Switch to change the switch-off time (e.g. to '2 hrs.').
- ▶ Press the 'Save' button.
'Saved' appears briefly on the display.
'Machine settings'
- P** ▶ Press the P button to exit programming mode.
'Please select product'

Energy-saving mode

In the programme item **'Machine settings' ('4/7) / 'Save energy'** you can permanently set an energy-saving mode (Energy Save Mode, E.S.M.®):

- **'Active'**
 - Soon after the last preparation, the JURA F9 stops heating up. After about 5 minutes the message **'Energy Save'** is displayed.
 - Before you can prepare a speciality coffee, speciality coffee with milk, or hot water, the machine must heat up.
- **'Inactive'**
 - All speciality coffees, speciality coffees with milk and hot water can be prepared without having to wait.

Example: Proceed as follows to change the energy-saving mode from **'Active'** to **'Inactive'**.

Precondition: **'Please select product'** is displayed.

- P** ▶ Press the P button.
'Maintenance status' ('1/7)
-  ▶ Turn the Rotary Switch until **'Machine settings' ('4/7)** is displayed.
- ▶ Press the **'Save energy'** button.
'Save energy'
- ▶ Press the **'Inactive'** button.
- ▶ Press the **'Save'** button.
'Saved' appears briefly on the display.
'Machine settings'
- P** ▶ Press the P button to exit programming mode.
'Please select product'

Maintenance settings

In the programme item **'Maintenance settings' ('6/7)** you can make the following settings:

- **'Use filter'**
 - Activate the CLARIS Blue filter cartridge (see Chapter 5 'Maintenance – Inserting and activating the filter').
- **'Water hardness'** (only if filter is not activated)
 - If you do not have a filter cartridge, you will need to set the water hardness (see Chapter 4 'Permanent settings in programming mode – Setting the water hardness').

- 'Switch-on rinse'
 - 'Manual': The switch-on rinse must be started manually.
 - 'Automatic': The switch-on rinse is started automatically.

Example: Proceed as follows to specify that the switch-on rinse should be started **manually**.

Precondition: 'Please select product' is displayed.

- P ▶ Press the P button.
 'Maintenance status' ('1/7')
- ⊗ ▶ Turn the Rotary Switch until 'Maintenance settings' ('6/7') is displayed.
 - ▶ Press the 'Switch-on rinse' button.
 'Switch-on rinse'
 - ▶ Press the 'Manual' button.
 - ▶ Press the 'Save' button.
 'Saved' appears briefly on the display.
 'Maintenance settings'
- P ▶ Press the P button to exit programming mode.
 'Please select product'

Setting the water hardness

- i** If you are using the CLARIS Blue filter cartridge and have activated it, it is not possible to set the water hardness.

The harder the water is, the more frequently the JURA F9 needs to be descaled. It is therefore important to set the water hardness accurately.

The water hardness can be adjusted on a continuous scale between 1 °dH and 30 °dH.

Precondition: 'Please select product' is displayed.

- P ▶ Press the P button.
 'Maintenance status' ('1/7')
- ⊗ ▶ Turn the Rotary Switch until 'Maintenance settings' ('6/7') is displayed.
 - ▶ Press the 'Water hardness' button.
 'Water hardness'
- ⊗ ▶ Turn the Rotary Switch to adjust the water hardness.
 - ▶ Press the 'Save' button.
 'Saved' appears briefly on the display.
 'Maintenance settings'

4 Permanent settings in programming mode

- P ▶ Press the P button to exit programming mode.
‘Please select product’

Display settings

In the programme item ‘Machine settings’ (‘5/7’) / ‘Display’ you can set the display brightness and contrast (as a percentage).

Precondition: ‘Please select product’ is displayed.

- P ▶ Press the P button.
‘Maintenance status’ (‘1/7’)
- ⊙ ▶ Turn the Rotary Switch until ‘Machine settings’ (‘5/7’) is displayed.
 - ▶ Press the ‘Display’ button.
‘Display’
- ⊙ ▶ Turn the Rotary Switch to change the display setting.
 - ▶ Press the ‘Save’ button.
‘Saved’ appears briefly on the display.
‘Machine settings’
- P ▶ Press the P button to exit programming mode.
‘Please select product’

Unit for amount of water

In the programme item ‘Machine settings’ (‘5/7’) / ‘Units’ you can select the unit used for the amount of water.

Example: Proceed as follows to change the unit for the amount of water from ‘ml’ to ‘oz’.

Precondition: ‘Please select product’ is displayed.

- P ▶ Press the P button.
‘Maintenance status’ (‘1/7’)
- ⊙ ▶ Turn the Rotary Switch until ‘Machine settings’ (‘5/7’) is displayed.
 - ▶ Press the ‘Units’ button.
‘Units’
 - ▶ Press the ‘oz’ button.
 - ▶ Press the ‘Save’ button.
‘Saved’ appears briefly on the display.
‘Machine settings’
- P ▶ Press the P button to exit programming mode.
‘Please select product’

Restore factory settings

In the programme item 'Machine settings' ('4/7') | 'Factory setting' the machine can be reset to its factory setting: **All user settings** (apart from the 'filter' and 'water hardness') are reset to factory settings. Your JURA F9 then switches off.

Precondition: 'Please select product' is displayed.

- P ▶ Press the P button.
'Maintenance status' ('1/7')
- ⊙ ▶ Turn the Rotary Switch until 'Machine settings' ('4/7') is displayed.
 - ▶ Press the 'Factory setting' button.
'Factory setting' | 'Reset the machine to the factory settings?'
 - ▶ Press the 'Yes' button.
'Saved' appears briefly on the display.
Your JURA F9 is switched off.

Language

In this programme item you can set the language used by your JURA F9.

Example: Proceed as follows to change the language from 'English' to 'Deutsch'.

Precondition: 'Please select product' is displayed.

- P ▶ Press the P button.
'Maintenance status' ('1/7')
- ⊙ ▶ Turn the Rotary Switch until 'Machine settings' ('4/7') is displayed.
 - ▶ Press the 'Choose language' button.
'Choose language'
- i ▶ To display more languages, press the '>' button (bottom right).
 - ▶ Press the 'Deutsch' button.
'Gespeichert' appears briefly on the display.
'Geräteeinstellungen'
- P ▶ Press the P button to exit programming mode.
'Bitte wählen'

Querying information

In the programme item 'Information' ('7/7') you can view the following information:

- 'Product counter': Number of prepared speciality coffees, speciality coffees with milk and hot water
- 'Maintenance counter': Number of maintenance programmes performed (cleaning, descaling etc.)
- 'Version': Software version

Example: Proceed as follows to view the number of speciality coffees prepared.

Precondition: 'Please select product' is displayed.

- P** ▶ Press the P button.
'Maintenance status' ('1/7')
-  ▶ Turn the Rotary Switch until 'Information' ('7/7') is displayed.
▶ Press the 'Product counter' button.
'Product counter'
- i** Press the '>' button (bottom right) to display the number of additional speciality coffees.
- P** ▶ Press the P button to exit programming mode.
'Please select product'

5 Maintenance

Your JURA F9 has the following integrated maintenance programmes:

- Rinsing the machine ('Rinse the coffee system')
- Rinsing the milk system in the dual spout ('Rinse the milk system')
- Cleaning the milk system in the dual spout ('Cappuccino cleaning')
- Changing the filter ('Change the filter') (only if filter is activated)
- Cleaning the machine ('Clean')
- Descaling the machine ('Descale') (only if filter is not activated)

i Clean or descale the machine, rinse the milk system or change the filter when you are prompted to do so.

i Press the P button to view a list of the maintenance programmes ('Maintenance status'). By referring to the bar you can see which maintenance programme is due. When the bar is completely filled with red, your JURA F9 will prompt you to perform the appropriate maintenance programme.

i In the interests of hygiene, you should clean the milk system **daily** when you have been preparing milk.

Rinsing the machine



You can initiate the rinse operation manually at any time.

Precondition: 'Please select product' is displayed.

- ▶ Place a receptacle under the dual spout.
- P** ▶ Press the P button.
 - 'Maintenance status' ('1/7')
- ⊙** ▶ Turn the Rotary Switch until 'Maintenance status' ('2/7') is displayed.
 - ▶ Press the 'Rinse the coffee system' button to initiate the rinse operation.
 - 'Machine is rinsing', water flows out of the dual spout.
 - The rinse stops automatically. 'Please select product' appears on the display.

Rinsing the milk system



After each milk preparation, the JURA F9 prompts you to perform a milk system rinsing.

Precondition: 'Rinse the milk system' is displayed.

- ▶ Place a receptacle under the dual spout.
- ▶ Press the Rotary Switch.
'Milk system is being rinsed', water flows out of the dual spout.
The rinse stops automatically. Your JURA F9 is once more ready for use.

Cleaning the milk system

To ensure that the milk system in the dual spout always works properly, you must clean it **daily** when you have been preparing milk.

CAUTION

If the wrong cleaning agent is used, the machine could be damaged and/or traces could be left behind in the water.

- ▶ Use only original JURA maintenance products.

i JURA milk system cleaner is available from specialised dealers.

Precondition: 'Please select product' is displayed.

- P** ▶ Press the P button.
'Maintenance status' ('1/7')
- ▶ Press the 'Cappuccino cleaning' button.
- ▶ Press the 'Start' button.
- ▶ Press the 'Start' button again.
'Cleaner for Cappuccino'
- ▶ Remove the milk pipe from the milk container or carton.
- ▶ Pour 250 ml of fresh water into a receptacle and add one capful of milk system cleaner.
- ▶ Immerse the milk pipe in the receptacle.
- ▶ Place another receptacle under the dual spout.
- ▶ Press the 'Next' button.
'Cleaning Cappuccino', the dual spout and the pipe are cleaned.
'Water for Cappuccino'
- ▶ Rinse the receptacle thoroughly, fill it with 250 ml of fresh water and immerse the milk pipe in the water.





- ▶ Empty the other receptacle and place it under the dual spout again.
- ▶ Press the 'Next' button.
 'Cleaning Cappuccino', the dual spout and the pipe are rinsed with fresh water.
 The operation stops automatically. 'Milk system cleaning complete' appears briefly on the display.
 Your JURA F9 is once more ready for use.

Dismantling and rinsing the dual spout

The dual spout must be dismantled and rinsed **daily** if milk has been prepared to make sure it functions perfectly and also in the interests of hygiene.

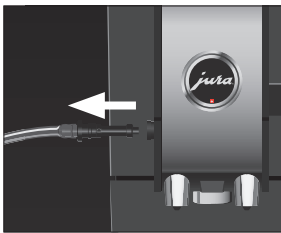

- ▶ Remove the milk pipe and rinse it thoroughly under running water.

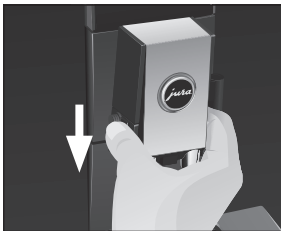

- ▶ Press the releasing devices and pull the dual spout down and off.

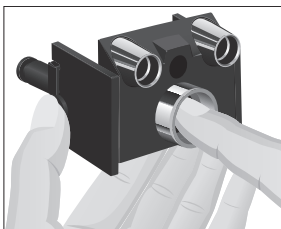

- ▶ Press the milk system down and take it out.

5 Maintenance

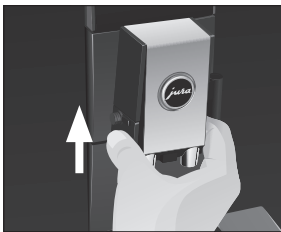
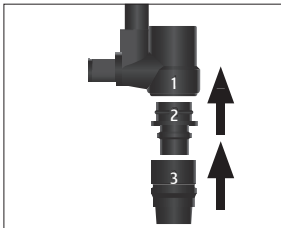
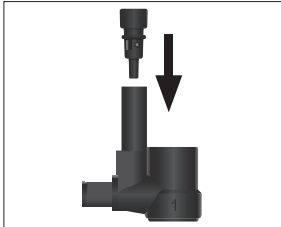
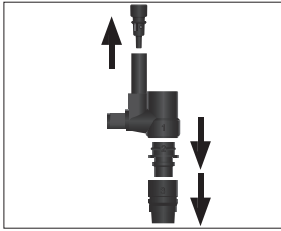

Inserting and activating the filter

Your JURA F9 no longer has to be descaled if you are using the CLARIS Blue filter cartridge. If you did not activate the filter cartridge the first time you used the machine, you can do this now as follows.

- i** Perform the 'inserting the filter' operation without any interruptions. This will ensure that your JURA F9 always produces its best.

Precondition: 'Please select product' is displayed.

- P** ▶ Press the P button.
'Maintenance status' ('1/7')

- ▶ Dismantle the milk system into its individual parts.
- ▶ Rinse all the parts under running water. If there are severely dried-on milk residues, firstly immerse the individual parts in a solution of 250 ml cold water and 1 capful of JURA milk system cleaner. Then rinse the parts thoroughly.

- ▶ Fit the air intake pipe.

- ▶ Reassemble the milk system. When doing this, note the numbering of the individual parts.
- ▶ Fit the assembled individual parts back in the dual spout and press it firmly.

- ▶ Fit the dual spout on the machine. It will click into place audibly.

- Turn the Rotary Switch until **'Maintenance settings' ('6/7')** is displayed.
- Press the **'Use filter'** button.
- Press the **'Active'** button.
- Press the **'Save'** button.
'Saved' appears briefly on the display.
- Remove and empty the water tank.
- Open the filter holder and insert the filter cartridge into the water tank, exerting slight pressure.
- Close the filter holder. It will click into place audibly.



- i** After two months, the filter will cease to work. Set the date on the date plate on the filter holder in the water tank.

- Fill the water tank with fresh, cold water and reinsert the tank.
- Press the **'Next'** button.
'Switch open'



- Place a receptacle under the hot-water spout.
- Turn the switch to the **⏴** position.
'Filter is being rinsed', water flows out of the hot-water spout.

- i** You can interrupt rinsing of the filter at any time. To do this, turn the switch clockwise. Turn the switch anticlockwise to continue rinsing the filter.

- i** The water may be slightly discoloured. This is not harmful to health and does not affect the taste.

Rinsing of the filter stops automatically after approximately 300 ml. **'Switch close'** appears on the display.

- Turn the switch to the **⏵** position.
'Please select product' appears on the display. The filter is now activated.

Changing the filter

- i** After 50 litres of water have flowed through, the filter will cease to work. Your JURA F9 will automatically prompt you to change the filter.

- i** After two months, the filter will cease to work. Set the date on the date plate on the filter holder in the water tank.
- i** If the CLARIS Blue filter cartridge is not activated in programming mode, you will not be prompted to change the filter.
- i** CLARIS filter cartridges are available from specialised dealers.

Precondition: 'Change the filter' is displayed.

- P**
- ▶ Press the P button.
'Maintenance status' ('1/7')
 - ▶ Press the 'Change the filter' button.
'Change the filter'
 - ▶ Press the 'Start' button.
 - ▶ Press the 'Start' button again.
'Change filter'
 - ▶ Remove and empty the water tank.
 - ▶ Open the filter holder and remove the old CLARIS Blue filter cartridge.
 - ▶ Insert a **new** CLARIS filter cartridge Blue into the water tank, exerting slight pressure.
 - ▶ Close the filter holder. It will click into place audibly.
 - ▶ Fill the water tank with fresh, cold water and reinsert the tank.



- ▶ Place a receptacle under the hot-water spout.
- ▶ Press the 'Next' button.
'Switch open'
- ⊖** ▶ Turn the switch to the  position.
'Filter is being rinsed', water flows out of the hot-water spout.

- i** You can interrupt rinsing of the filter at any time. To do this, turn the switch clockwise. Turn the switch anticlockwise to continue rinsing the filter.
- i** The water may be slightly discoloured. This is not harmful to health and does not affect the taste.

Rinsing of the filter stops automatically after approximately 300 ml. 'Switch close' appears on the display.

- i** ▶ Turn the switch to the  position.
'Please select product' appears on the display.

Cleaning the machine



After 200 preparations or 80 switch-on rinses, the JURA F9 will prompt you to clean it.

CAUTION If the wrong cleaning agent is used, the machine could be damaged and/or traces could be left behind in the water.

- ▶ Use only original JURA maintenance products.

- i** The cleaning programme lasts approximately 20 minutes.
- i** Do not interrupt the cleaning programme. The quality of cleaning will be impaired if you do so.
- i** JURA cleaning tablets are available from specialised dealers.

Precondition: 'Clean machine' is displayed.

- P** ▶ Press the P button.
- 'Maintenance status' ('1/7')
- ▶ Press the 'Clean' button.
 - 'Clean'
 - ▶ Press the 'Start' button.
 - ▶ Press the 'Start' button again.
 - 'Empty grounds'
 - ▶ Empty the drip tray and coffee grounds container and put them back into the machine.
 - 'Press the Rotary Switch'
 - ▶ Place a receptacle under the dual spout.
 -  ▶ Press the Rotary Switch.
 - 'Machine is being cleaned', water flows out of the dual spout. The operation is interrupted, 'Add cleaning tablet'.
 - ▶ Open the cover of the filler funnel for ground coffee.
 - ▶ Insert a JURA cleaning tablet into the filler funnel.
 - ▶ Close the cover of the filler funnel.
 - 'Press the Rotary Switch'
 -  ▶ Press the Rotary Switch.
 - 'Machine is being cleaned', water flows out of the dual spout repeatedly. The operation stops automatically.
 - 'Empty grounds'



- ▶ Empty the drip tray and coffee grounds container and put them back into the machine.
‘Please select product’ appears on the display. Cleaning is now complete.

Descaling the machine

The JURA F9 builds up deposits of limescale over time and automatically prompts you to descale it when necessary. The degree of calcification depends on the hardness of your water.

- i** If you use a CLARIS Blue filter cartridge and this is activated, you will not be prompted to descale.

⚠ CAUTION If the descaling agent comes into contact with the skin or eyes, this can cause irritation.

- ▶ Avoid contact with the skin or eyes.
- ▶ Rinse off the descaling agent with clean water. Should you get any descaling agent in your eye, see a doctor.

CAUTION If the wrong descaling agent is used, the machine could be damaged and/or traces could be left behind in the water.

- ▶ Use only original JURA maintenance products.

CAUTION If the descaling operation is interrupted, there may be damage to the machine.

- ▶ Allow the descaling programme to run to the end.

CAUTION If the descaling agent comes into contact with sensitive surfaces (e.g. marble), damage cannot be ruled out.

- ▶ Clean up any splashes immediately.

-
- i** The descaling programme lasts approximately 40 minutes.

- i** JURA descaling tablets are available from specialised dealers.

Precondition: ‘Decalcify machine’ is displayed.

- P**
- ▶ Press the P button.
‘Maintenance status’ (‘1/7’)
 - ▶ Press the ‘Descal’ button.
‘Descal’
 - ▶ Press the ‘Start’ button.
 - ▶ Press the ‘Start’ button again.
‘Empty drip tray’

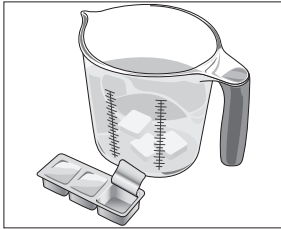

- ▶ Empty the drip tray and coffee grounds container and put them back into the machine.

'Agent in tank'

- ▶ Remove and empty the water tank.
- ▶ Completely dissolve the contents of one blister (3 JURA descaling tablets) in a receptacle holding 500 ml of lukewarm water. This may take several minutes.
- ▶ Pour the solution into the empty water tank and insert it into the machine.

'Switch open'

- ▶ Place a receptacle under the hot-water spout and dual spout.
 - ▶ Turn the switch to the  position.
- 'Machine is being descaled'**, water flows out of the hot-water spout repeatedly.

The operation is interrupted, **'Switch close'**.

- ▶ Turn the switch to the  position.
- 'Machine is being descaled'**, the descaling operation is continued. Water flows out of the dual spout repeatedly.
- The operation is interrupted, **'Empty drip tray'**.
- ▶ Empty the drip tray and coffee grounds container and put them back into the machine.

'Fill water tank.'

- ▶ Empty the receptacle and place it under the hot water and dual spouts.
- ▶ Remove the water tank and rinse it thoroughly.
- ▶ Fill the water tank with fresh, cold water and reinsert the tank.

'Switch open'

- ▶ Turn the switch to the  position.
- 'Machine is being descaled'**, the descaling operation is continued.
- The operation is interrupted, **'Switch close'**.

- ▶ Turn the switch to the  position.
- 'Machine is being descaled'**, the descaling operation is continued.

The operation is interrupted, **'Machine is being descaled'**.

Water flows out of the dual spout.

'Empty drip tray'

- ▶ Empty the drip tray and coffee grounds container and put them back into the machine.
'Please select product' appears on the display. Descaling is now complete.

i If the descaling operation stops unexpectedly, rinse the water tank thoroughly.

Descaling the water tank



Limescale deposits may form in the water tank. To ensure correct function of the machine, descale the water tank from time to time.

- ▶ Remove the water tank.
- ▶ If you use a CLARIS Blue filter cartridge, remove this.
- ▶ Completely fill the water tank and dissolve 3 JURA descaling tablets in it.
- ▶ Leave the water tank with the descaling solution for several hours (e.g. overnight).
- ▶ Empty the water tank and rinse it thoroughly.
- ▶ If you use a CLARIS Blue filter cartridge, insert this again.
- ▶ Fill the water tank with fresh, cold water and reinsert the tank.

Cleaning the bean container

Coffee beans may be covered with a slight oil film which remains on the walls of the bean container. These traces may negatively affect the coffee result. For this reason clean the bean container from time to time.

Precondition: 'Fill bean container' is displayed.

-  ▶ Switch the machine off with the On/Off button.
-  ▶ Switch the machine off at the power switch.
- ▶ Remove the aroma preservation cover.
- ▶ Clean the bean container with a soft, dry cloth.
- ▶ Fill the bean container with coffee beans and close the aroma preservation cover.

6 Display messages

Message	Cause/Result	Action
'Fill water tank.'	The water tank is empty. You cannot prepare any products.	▶ Fill the water tank (see Chapter 1 'Preparing and using for the first time – Filling the water tank').
'Empty grounds'	The coffee grounds container is full. You cannot prepare any products.	▶ Empty the coffee grounds container and the drip tray (see Chapter 3 'Daily operation – Daily maintenance').
'Drip tray not fitted'	The drip tray is not inserted correctly or is not inserted at all. You cannot prepare any products.	▶ Fit the drip tray.
'Fill bean container'	The bean container is empty. You cannot prepare any products.	▶ Fill the bean container (see Chapter 1 'Preparing and using for the first time – Filling the bean container').
'Rinse the milk system'	The JURA F9 requests a milk system rinsing.	▶ Perform milk system rinsing (see Chapter 5 'Maintenance – Rinsing the milk system').
'Change the filter'	The filter cartridge no longer works.	▶ Replace the CLARIS Blue filter cartridge (see Chapter 5 'Maintenance – Changing the filter').
'Clean machine'	The JURA F9 is prompting you to clean it.	▶ Perform cleaning (see Chapter 5 'Maintenance – Cleaning the machine').
'Decalcify machine'	The JURA F9 is prompting you to descale it.	▶ Perform descaling (see Chapter 5 'Maintenance – Descaling the machine').
'Not enough ground coffee'	There is insufficient ground coffee in the machine; the JURA F9 stops the operation.	▶ The next time you prepare a beverage, add more ground coffee (see Chapter 2 'Preparation – Ground coffee').
'Too hot'	The system is too hot to start a maintenance programme.	▶ Wait for several minutes until the system has cooled or prepare a speciality coffee or hot water.

7 Troubleshooting

Problem	Cause/Result	Action
Insufficient foam is produced when the milk is frothed, or milk sprays from the dual spout.	The dual spout is dirty.	<ul style="list-style-type: none"> ▶ Clean the milk system in the dual spout (see Chapter 5 'Maintenance – Cleaning the milk system'). ▶ Dismantle and rinse the dual spout (see Chapter 5 'Maintenance – Dismantling and rinsing the dual spout').
Coffee only comes out in drips when it is being prepared.	Coffee or ground coffee has been ground too finely and is blocking the system. The same filter cartridge may have been used several times or the water hardness set incorrectly in the programming mode.	<ul style="list-style-type: none"> ▶ Put the grinder on a coarser setting or use coarser ground coffee (see Chapter 2 'Preparation – Adjusting the grinder'). ▶ Perform descaling (see Chapter 5 'Maintenance – Descaling the machine').
Water hardness cannot be adjusted.	The CLARIS Blue filter cartridge is activated.	<ul style="list-style-type: none"> ▶ Deactivate the filter cartridge in programming mode.
'Fill water tank.' is displayed although the water tank is full.	The water tank float is trapped.	<ul style="list-style-type: none"> ▶ Descale the water tank (see Chapter 5 'Maintenance – Descaling the water tank').
Grinder is making a very loud noise.	There are foreign objects in the grinder.	<ul style="list-style-type: none"> ▶ Contact customer support in your country (see Chapter 11 'JURA contact details / Legal information').
'Error 2' or 'Error 5' is displayed.	If the machine was exposed to the cold for a long period of time, heating is disabled for safety reasons.	<ul style="list-style-type: none"> ▶ Warm the machine at room temperature.
Other 'Error' messages are displayed.	–	<ul style="list-style-type: none"> ▶ Switch the JURA F9 off at the power switch. Contact customer support in your country (see Chapter 11 'JURA contact details / Legal information').

i If you were unable to solve the problem, contact customer support in your country (see Chapter 11 'JURA contact details / Legal information').

8 Transport and environmentally friendly disposal

Transport / Emptying the system



Keep the packaging for your JURA F9. It should be used to protect the machine during transport.

In order to protect the JURA F9 from frost during transport, the system must be emptied.

Precondition: 'Please select product' is displayed.

- ▶ Remove the milk pipe from the dual spout.
- ▶ Place a receptacle under the hot-water spout.
- ⌚ ▶ Turn the Rotary Switch to view the product selector.
- ⌚ ▶ Turn the Rotary Switch until the 'Portion milk foam' product is in focus.
- ⌚ ▶ Press the Rotary Switch.
'Portion milk foam', hot steam is discharged from the dual spout.
- ▶ Remove and empty the water tank.
- ▶ Turn the Rotary Switch until 'Amount of milk' '60 sec.' is displayed.
Steam will continue to be discharged from the dual spout until the system is empty.
- 'Fill water tank.'
- ⏻ ▶ Press the On/Off button.
Your JURA F9 is switched off.

Disposal

Please dispose of old machines in an environmentally neutral way.



Old machines contain valuable, recyclable materials which should be recycled. Please therefore dispose of old machines via suitable collection systems.

9 Technical data

Voltage	220–240 V ~, 50 Hz
Power	1450 W
Conformity mark	CE
Energy consumption 'Save energy' / 'Active'	approx. 5 Wh
Energy consumption 'Save energy' / 'Inactive'	approx. 16 Wh
Pump pressure	static, max. 15 bar
Holding capacity of water tank	1.9 l
Holding capacity of bean container	310 g
Holding capacity of coffee grounds container	max. 15 portions
Cable length	approx. 1.1 m
Weight	approx. 9.8 kg
Dimensions (W × H × D)	28.5 × 35.5 × 44.5 cm

Information for testers (repeat test in accordance with DIN VDE 0701-0702): The central grounding point (CGP) is located on the underside of the machine, right next to the mains cable's connection point.

10 Index

A

- Addresses 52
- Adjusting the product settings 24
- Aroma preservation cover
 - Bean container with aroma preservation cover 4
- Automatic switch-off 27

B

- Bean container
 - Bean container with aroma preservation cover 4
 - Cleaning 42
 - Filling 10
- Bus bar
 - Technical data 46
- Button
 - On/Off button 5
 - P button (programming) 5

C

- Caffè latte 17
- Cappuccino 17
- Cappuccino frother cleaning
 - Cleaning the milk system 34
- Cappuccino frother rinsing
 - Rinsing the milk system 34
- Central grounding point 46
- Changing a name 26
- CLARIS Blue filter cartridge
 - Changing 37
 - Inserting and activating the filter 36
- Classics 24
- Cleaning
 - Bean container 42
 - Machine 39
- Coffee 16
 - 2 coffees 16
- Coffee grounds container 4
- Consistency of grind
 - Adjusting the grinder 20
 - Grinder adjustment switch 4
- Contact details 52

Cover

- Filler funnel for ground coffee 4
- Storage compartment 4
- Water tank 4
- Cup grille 4
- Customer support 52

D

- Descaling
 - Machine 40
 - Water tank 42
- Display 5
- Display messages 43
- Display settings 30
- Disposal 45
- Double product 16
- Drip tray 4
- Dual spout
 - Dismantling and cleaning 35
 - Height-adjustable dual spout 4

E

- Emptying the system 45
- Energy-saving mode 28
- Errors
 - Troubleshooting 44
- Espresso
 - 2 espressi 16
- Espresso 16
- Espresso macchiato 17
- Expert mode 24

F

- Factory settings
 - Restore factory settings 31
- Filler funnel
 - Filler funnel for ground coffee 4
- Filling
 - Bean container 10
 - Water tank 14
- Filter
 - Changing 37
 - Inserting and activating the filter 36
- First-time use 10
 - With filter cartridge activation 11
 - Without filter cartridge activation 12
- Flat white 17

G

- Grinder adjustment switch 4
- Ground coffee 18
 - Measuring spoon for ground coffee 4
- Grounding point 46

H

- Hotline 52
- Hot water 20
- Hot water preparation
 - Switch for hot water preparation 5
- Hot-water spout 4

I

- Instant coffee
 - Ground coffee 18
- Internet 10

J

- JURA
 - Contact details 52
 - Internet 10

L

- Language 31
- latte macchiato 17

M

- Machine
 - Cleaning 39
 - Descaling 40
 - Regular maintenance 22
 - Rinsing 33
 - Setting up 10
 - Switching off 22
 - Switching on 21
- Mains cable 4
- Maintenance 33
 - Daily maintenance 21
 - Regular maintenance 22
- Maintenance settings 28
- Measuring spoon for ground coffee 4
- Messages, display 43
- Milk
 - Connecting milk 14
- Milk system
 - Cleaning 34
 - Rinsing 34

P

- Permanently setting the water for the cup size 19
- Permanent settings in programming mode 23
- Power switch 4
- Preparation 15, 17
 - 2 coffees 16
 - 2 espressi 16
 - 2 ristretti 16
 - At the touch of a button 15
 - Caffè latte 17
 - Cappuccino 17
 - Coffee 16
 - Espresso 16
 - Espresso macchiato 17
 - Flat white 17
 - Ground coffee 18
 - Hot water 20
 - Latte macchiato 17
 - Ristretto 16
 - Two speciality coffees 16
 - Using the product selector 15
- Preparation options 15
- Problems
 - Troubleshooting 44
- Product selector view 15
- Product settings 24
 - Adjusting 24
- Programming mode 23
 - Automatic switch-off 27
 - Display settings 30
 - Energy-saving mode 28
 - Language 31
 - Maintenance settings 28
 - Product settings 24
 - Querying information 32
 - Renaming a product 26
 - Replacing products on the start screen 25
 - Restore factory settings 31
 - Setting the water hardness 29
 - Unit for amount of water 30
- Proper use 6

Q

- Querying information 32

R

- Regular maintenance 22
- Renaming a product 26
- Rinsing
 - Machine 33
- Ristretto 16
 - 2 ristretti 16
- Rotary Selection 15
- Rotary Switch 5

S

- Safety 6
- Safety information 6
- Settings
 - Maintenance settings 28
 - Permanent settings in programming mode 23
- Setting up
 - Setting up the machine 10
- Short operating instructions 10
- Spout
 - Height-adjustable dual spout 4
 - Hot-water spout 4
- Switch for hot water preparation 5
- Switching off 22
- Switching on 21
- Switch-off
 - Automatic switch-off 27
- Symbol description 3

T

- Technical data 46
- Tel 52
- Transport 45
- Troubleshooting 44
- Two products 16

U

- Unit for amount of water 30
- Use, First-time 10

W

- Water hardness
 - Determining the water hardness 13
 - Setting the water hardness 29
- Water tank 4
 - Descaling 42
 - Filling 14
- Website 10

11 JURA contact details / Legal information

JURA Elektroapparate AG
Kaffeeweltstrasse 10
CH-4626 Niederbuchsiten
Tel. +41 (0)62 38 98 233

@ You will find additional contact details for your country at
www.jura.com.

- Directives** The machine complies with the following directives:
- 2006/95/EC – Low Voltage Directive
 - 2004/108/EC – Electromagnetic Compatibility
 - 2009/125/EC – Ecodesign Directive
 - 2011/65/EU – RoHS Directive

Technical changes We reserve the right to make technical changes. The diagrams used in these instructions for use are for illustration purposes only and do not represent the original colours of the machine. Some details of your JURA F9 may vary.

Feedback Your opinion is important to us! Use the contact details at www.jura.com.

Copyright The instructions for use contain information which is protected by copyright. It is not permitted to photocopy these instructions for use or translate them into another language without the prior written consent of JURA Elektroapparate AG.